

POPIS PRODUKTU

- Navrženo pro dosažení krytí IP65
- Krytí nerovných okrajů drážky
- Jednoduchá montáž
- Výška profilu nepřesahuje výšku sádkartonových desek

ÚPRAVA :

Stříbrně anodizovaný

*Vlastní barvy jsou k dispozici na vyžádání

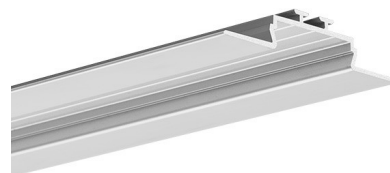

Vyplňte prázdná pole

Číslo produktu

Typ
příslušenství

Firma

Projekt

Datum

TECHNICKÁ SPECIFIKACE

Účel produktu

- k vytváření svítidel zabudovaných v plytkách drážkách

Instalace

- v drážkách použitím pružin do drážek KMA nebo montážních lepidel

Další informace

- možnost výroby liniového svítidla s krytím IP65 - tedy svítidlo prachotěsné a odolné vůči tryskající vodě
- získání krytí IP65 je možné použitím difuzorů: LIGER-22, MUN-22 i HS-22
- širší křídélka umožňují překrytí nepřesně vyfrézované drážky
- prostor pro LED pásek: 21.8 mm

DOSTUPNÉ DÉLKY

Ref.	povrchová úprava	dostupné délky
B6164ANODA_1	Stříbrně anodizovaný	1000 mm
B6164ANODA_2	Stříbrně anodizovaný	2000 mm
B6164ANODA_3	Stříbrně anodizovaný	3000 mm

TECHNICKÝ VÝKRES

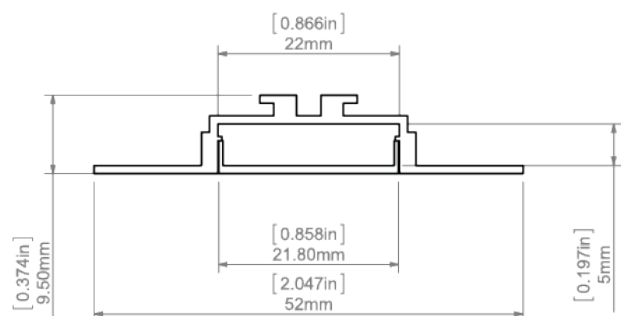

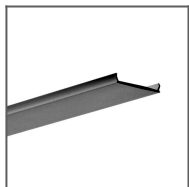
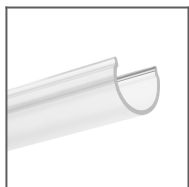
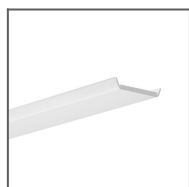
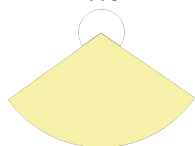
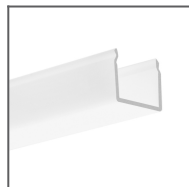
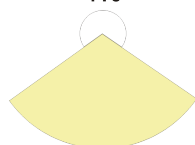
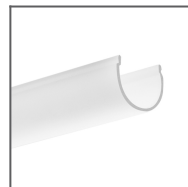
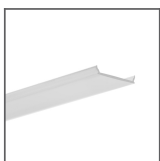
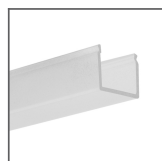
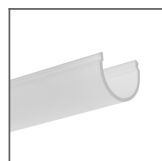
SOUVISEJÍCÍ PRODUKTY**DIFUZORY****ČERNÉ DIFUZORY**Difuzor LIGER-22
černý
Ref: 17087**ČIRÉ DIFUZORY**Difuzor G-L čirý
Ref: 17006Difuzor HS-22 čirý
Ref: 17022**MLÉČNÉ DIFUZORY**Difuzor LIGER-22
mléčný
Ref: 17032V1**110°**Difuzor HS-22 mléčný
Ref: 17011**110°**Difuzor G-K
mléčný
Ref: 17007Difuzor G-L
mléčný
Ref: 00413**MRAŽENÉ DIFUZORY**Difuzor MUN-22
mražený
Ref: 17042**100°**Difuzor G-K
mražený
Ref: 00415Difuzor G-L
mražený
Ref: 17008

ZÁSLEPKY

ZÁKLADNÍ

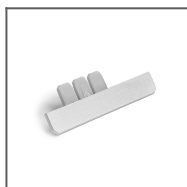
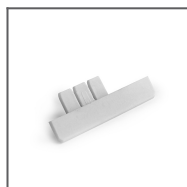
Záslepka
OPAC-30
metalická
Ref: 24052Záslepka
OPAC-30 šedá
Ref: 24045

PŘÍSLUŠENSTVÍ

ZÁVĚSNÉ PRVKY

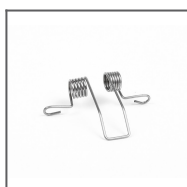
Pružina KMA
Ref: 00838V1

SPOJOVACÍ PRVKY PROFILŮ

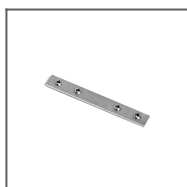
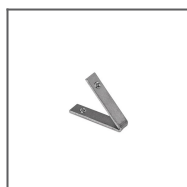
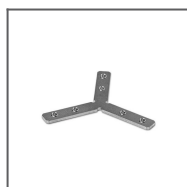
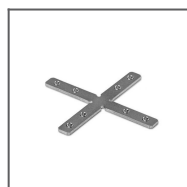
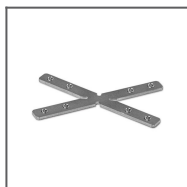
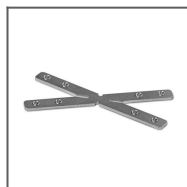
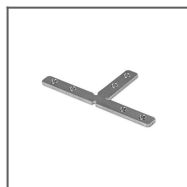
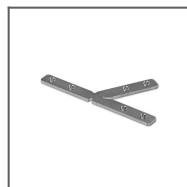
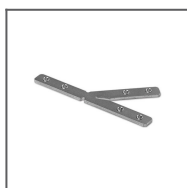
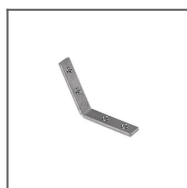
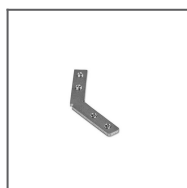
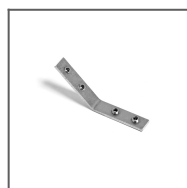
Úhlová spojka
ZM-180
Ref: 42717Úhlová spojka
ZM-PION-45
Ref: 42314Úhlová spojka
ZM-Y120-G
Ref: 42336Úhlová spojka
ZM-X90-G
Ref: 42334Úhlová spojka
ZM-X60-G
Ref: 42332Úhlová spojka
ZM-X45-G
Ref: 42330Úhlová spojka
ZM-T90-G
Ref: 42328Úhlová spojka
ZM-T60-G
Ref: 42326Úhlová spojka
ZM-T45-G
Ref: 42324Úhlová spojka
ZM-PION-120
Ref: 42320Úhlová spojka
ZM-135-G
Ref: 42310Úhlová spojka
ZM-PION-135
Ref: 42719

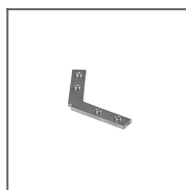
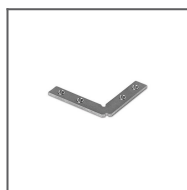
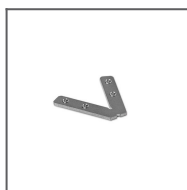
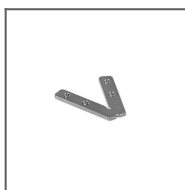
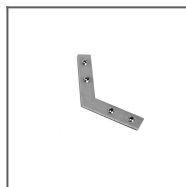
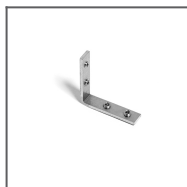
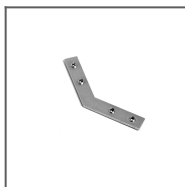
Úhlová spojka
ZM-120-G
Ref: 42308Úhlová spojka
ZM-90-G
Ref: 42306Úhlová spojka
ZM-60-G
Ref: 42304Úhlová spojka
ZM-45-G
Ref: 42338Úhlová spojka
ZM-120
Ref: 42728Úhlová spojka
ZM-90
Ref: 42716Úhlová spojka
ZM-PION-90
Ref: 42718Úhlová spojka
ZM-135
Ref: 42720Úhlová spojka
ZM-MINI-180
Ref: 44501

TĚSNÍCÍ PRVKY

Gumová
průchodka 6,4x3
Ref: 42264

OSTATNÍ PŘÍSLUŠENSTVÍ

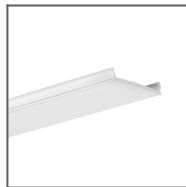
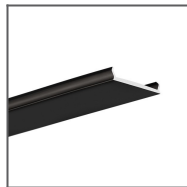
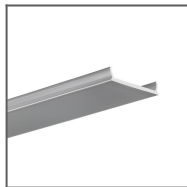
Krycí difuzor
MP-22 bílý
Ref: 17167L9010Krycí difuzor
MP-22 černý
Ref: 17167L9005Krycí difuzor
MP-22 metalický
Ref: 17167

LED PÁSKY

BÍLÁ

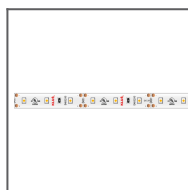

LED pásek K-1210-12V
4.8 W/m
Ref: K-1210-12V

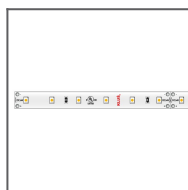

LED pásek K-1210-24V 4.8W/m
Ref: K-1210-24V



LED pásek K-1220-12V 9.6W/m
Ref: K-1220-12V

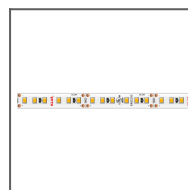

LED pásek K-1220-24V 9.6W/m
Ref: K-1220-24V

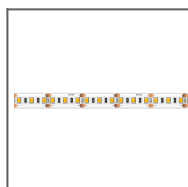

LED pásek K-1275-12V 14.4W/m
Ref: K-1275-12V

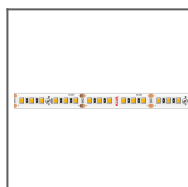

LED pásek K-1275-24V 14.4W/m
Ref: K-1275-24V

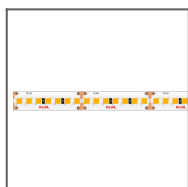

LED pásek K-1820-HD-24V 18.2W/m
Ref: K-1820-HD-24V



LED pásek K-1910-HD-24V 9.1W/m
Ref: K-1910-HD-24V

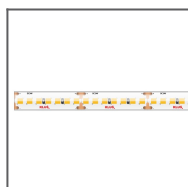

LED pásek WP-1640-HD-IP65-24V 16.4W/m
Ref: WP-K-1640-HD-IP65-24V

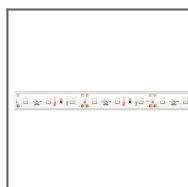

LED pásek WP-K-1210-12V
Ref: WP-K-1210-12V



LED pásek WP-K-1210-24V
Ref: WP-K-1210-24V

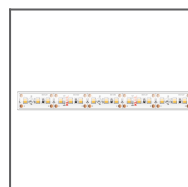

LED pásek WP-K-1220-12V
Ref: WP-K-1220-12V

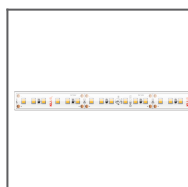

LED pásek WP-K-1220-24V
Ref: WP-K-1220-24V

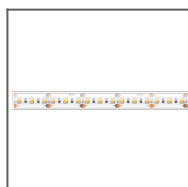

LED pásek WP-K-1275-12V
Ref: WP-K-1275-12V

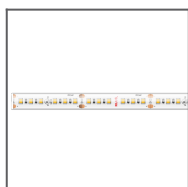

LED pásek WP-K-1275-24V
Ref: WP-K-1275-24V

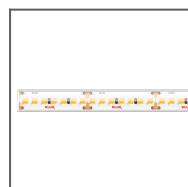

LED pásek WP-K-1820-HD-24V
Ref: WP-K-1820-HD-24V

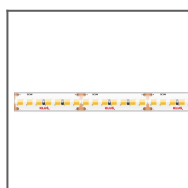

LED pásek WP-K-1910-HD-IP65-24V 9.1W/m
Ref: WP-K-1910-HD-IP65-24V

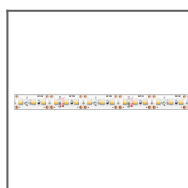

LED pásek WP-K-1220-IP65-12V 9.6W/m
Ref: WP-K-1220-IP65-12V



LED pásek WP-K-1220-IP65-24V 9.6 W/m
Ref: WP-K-1220-IP65-24V



LED pásek K-LR-1000-24V 10W/m
Ref: K-LR-1000-24V

RGB / RGB-W

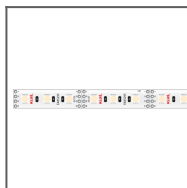

LED pásek K-1275-RGB-12V 14.4W/m
Ref: K-1275-RGB-12V

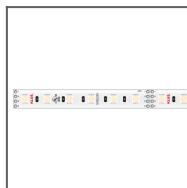

LED pásek K-1275-RGB-24V 14.4W/m
Ref: K-1275-RGB-24V

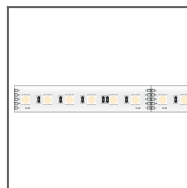

LED pásek K-1920-RGB+W-24V 19.2W/m
Ref: K-1920-RGB+W-24V



LED pásek WP-K-1275-RGB-12V
Ref: WP-K-1275-RGB-12V

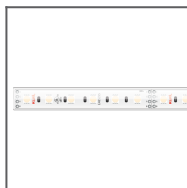

LED pásek WP-K-1275-RGB-24V
Ref: WP-K-1275-RGB-24V

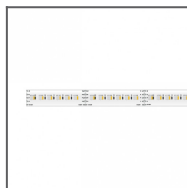

LED pásek K-1530-RGB+W-24V 15.3W/m
Ref: K-1530-RGB+W-24V

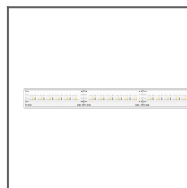

LED pásek WP-K-1530-RGB+W-24V
Ref: WP-K-1530-RGB+W-24V

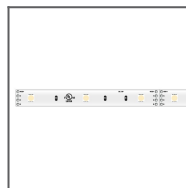

LED pásek K-1215-RGB-12V 7.2W/m
Ref: K-1215-RGB-12V

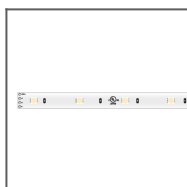

LED pásek K-1215-RGB-24V 7.2W/m
Ref: K-1215-RGB-24V

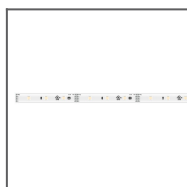

LED pásek K-1225-RGB-12V 11.5W/m
Ref: K-1225-RGB-12V

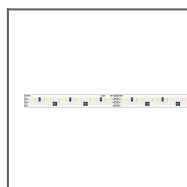

LED pásek K-1225-RGB-24V 11.5W/m
Ref: K-1225-RGB-24V



LED pásek WP-K-1215-RGB-12V 7.2W/m
Ref: WP-K-1215-RGB-12V



LED pásek WP-K-1215-RGB-24V
Ref: WP-K-1215-RGB-24V

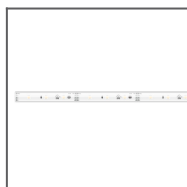

LED pásek WP-K-1225-RGB-12V
Ref: WP-K-1225-RGB-12V

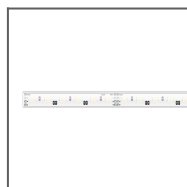

LED pásek WP-K-1225-RGB-24V
Ref: WP-K-1225-RGB-24V

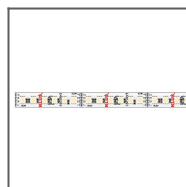

LED pásek K-1920-120-RGB-24V 19.2W/m
Ref: K-1920-120-RGB-24V

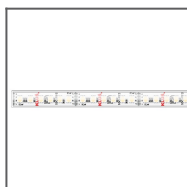

LED pásek WP-K-1920-120-RGB-24V
Ref: WP-K-1920-120-RGB-24V

NASTAVENÍ TEPLoty BARVY / TEPLÉ BARVY

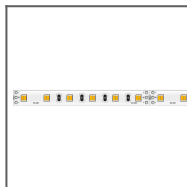

LED pásek
K-27/65-1920-24V
19.2W/m
Ref:
K-27/65-1920-24V

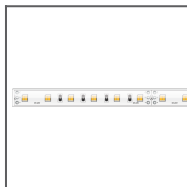

LED pásek WP-
K-27/65-1920-24V
Ref: WP-
K-27/65-1920-24V

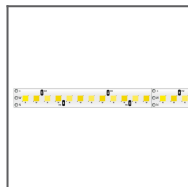

LED pásek
K-22/50-1728-24V
17.28W/m
Ref:
K-22/50-1728-24V

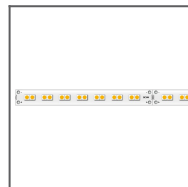

LED pásek
K-30/18-1770-24V
11.5W/m
Ref:
K-30/18-1770-24V

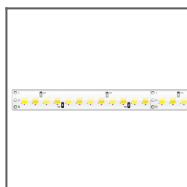

LED pásek WP-
K-22/50-1728-24V
Ref: WP-
K-22/50-1728-24V

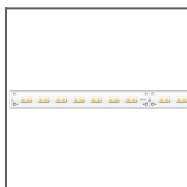

LED pásek WP-
K-30/18-1770-24V
Ref: WP-
K-3018-1770-24V