

## POPIS PRODUKTU

- Osvětlení nik s efektem tenkého okraje zavěšeného stropu
- Možnost instalace v libovolné vzdálenosti od okraje niky
- Snadný servis

ÚPRAVA :

Neanodizovaný (surový) 

\*Vlastní barvy jsou k dispozici na vyžádání



Vyplňte prázdná pole

Číslo produktu

Typ  
příslušenství

Firma

Projekt

Datum

## TECHNICKÁ SPECIFIKACE

### Účel produktu

- ambientní osvětlení architektonických nik nacházející se v libovolné vzdálenosti od stěny
- světlo směřuje ke stropu

### Instalace

- pomocí vrutů vhodně zvolených pro daný typ podkladu

### Další informace

- možnost instalace svisle i vodorovně
- zdroj světla v jednoduše demontovatelném světelném profilu ONISA
- prostor pro LED pásek 11.2 mm

## DOSTUPNÉ DÉLKY

| Ref.      | povrchová úprava       | dostupné délky |
|-----------|------------------------|----------------|
| 18026NA_1 | Neanodizovaný (surový) | 1000 mm        |
| 18026NA_2 | Neanodizovaný (surový) | 2000 mm        |
| 18026NA_3 | Neanodizovaný (surový) | 3000 mm        |

TECHNICKÝ VÝKRES

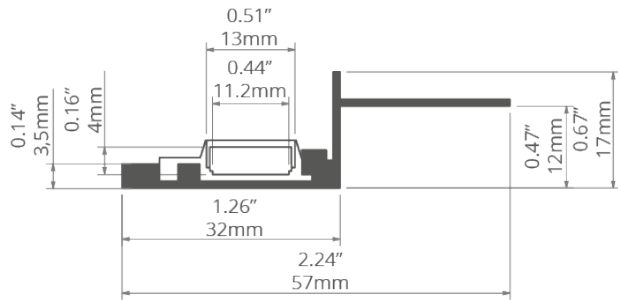

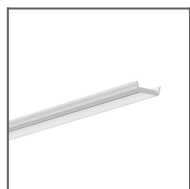
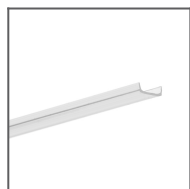
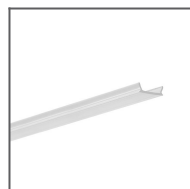
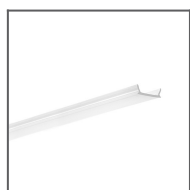
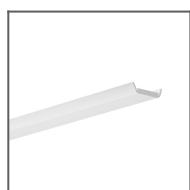
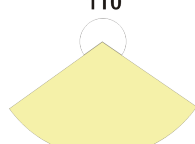
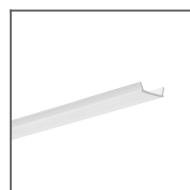
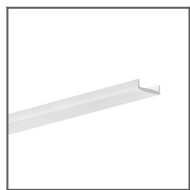
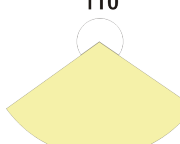
**SOUVISEJÍCÍ PRODUKTY****DIFUZORY****ČIRÉ DIFUZORY**Difuzor KA čirý  
Ref: 17036**110°**Difuzor HS čirý  
Ref: 1370**110°**Difuzor KA-COM čirý  
Ref: 17122**100°**Difuzor KA-PRO čirý  
Ref: 17065**100°****MLÉČNÉ DIFUZORY**Difuzor KA mléčný  
Ref: 17035**110°**Difuzor KA-PRO  
mléčný  
Ref: 17064**110°**Difuzor HS mléčný  
Ref: 1369**110°**Difuzor KA-COM  
mléčný  
Ref: 17121**110°**Difuzor LIGER mléčný  
Ref: 17037**120°****ZÁSLEPKY****ZÁKLADNÍ**



Záslepka ONISA  
šedá  
Ref: 24100

## PŘÍSLUŠENSTVÍ

### SPOJOVACÍ PRVKY PROFILŮ

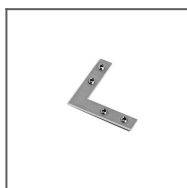

Úhlová spojka  
ZM-NA-90  
Ref: 42723

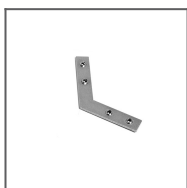

Úhlová spojka  
ZM-NA-120  
Ref: 42729

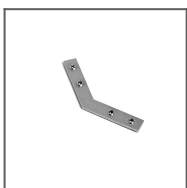

Úhlová spojka  
ZM-NA-135  
Ref: 42725



Úhlová spojka  
ZM-NA-180  
Ref: 42724

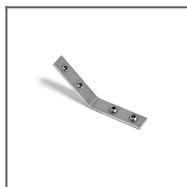

Úhlová spojka  
ZM-NA-PION-135  
Ref: 42727



Úhlová spojka  
ZM-NA-PION-90  
Ref: 42726



Úhlová spojka  
ZM-NA-45  
Ref: 42339



Úhlová spojka  
ZM-NA-PION-120  
Ref: 42321

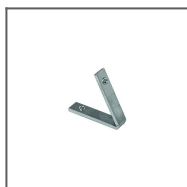

Úhlová spojka  
ZM-NA-PION-60  
Ref: 42317



Úhlová spojka  
ZM-NA-PION-45  
Ref: 42315

### TĚSNÍCÍ PRVKY



Gumová  
průchodka 6x1,2  
Ref: 00802

### LED PÁSKY

## BÍLÁ

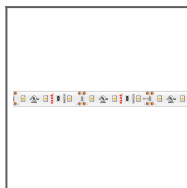

LED pásek  
K-1210-12V 4.8  
W/m  
Ref: K-1210-12V

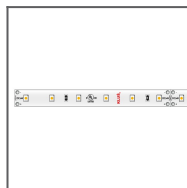

LED pásek  
K-1210-24V  
4.8W/m  
Ref: K-1210-24V

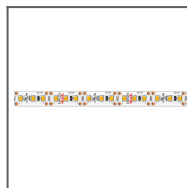

LED pásek  
K-1220-12V  
9.6W/m  
Ref: K-1220-12V

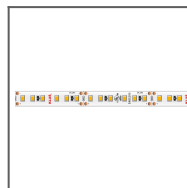

LED pásek  
K-1220-24V  
9.6W/m  
Ref: K-1220-24V

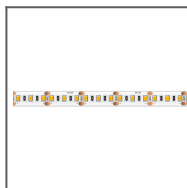

LED pásek  
K-1275-12V  
14.4W/m  
Ref: K-1275-12V

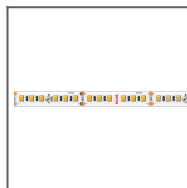

LED pásek  
K-1275-24V  
14.4W/m  
Ref: K-1275-24V



LED pásek  
K-1820-HD-24V  
18.2W/m  
Ref: K-1820-  
HD-24V



LED pásek  
K-1910-HD-24V  
9.1W/m  
Ref: K-1910-  
HD-24V

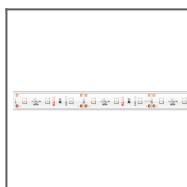

LED pásek WP-  
K-1210-12V  
Ref: WP-  
K-1210-12V

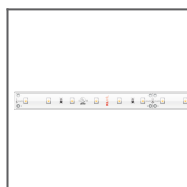

LED pásek WP-  
K-1210-24V  
Ref: WP-  
K-1210-24V

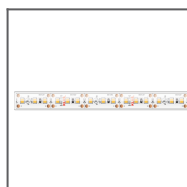

LED pásek WP-  
K-1220-12V  
Ref: WP-  
K-1220-12V



LED pásek K-  
LR-1000-24V  
10W/m  
Ref: K-  
LR-1000-24V

## RGB / RGB-W

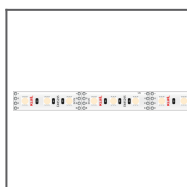

LED pásek K-1275-  
RGB-12V 14.4W/m  
Ref: K-1275-  
RGB-12V

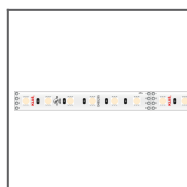

LED pásek K-1275-  
RGB-24V 14.4W/m  
Ref: K-1275-RGB-24V



LED pásek WP-  
K-1275-RGB-12V  
Ref: WP-K-1275-  
RGB-12V

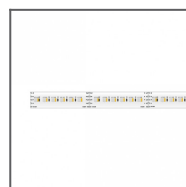

LED pásek K-1530-  
RGB+W-24V  
15.3W/m  
Ref: K-1530-  
RGB+W-24V

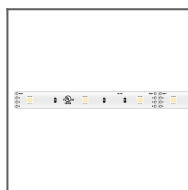

LED pásek K-1215-RGB-12V 7.2W/m  
Ref: K-1215-RGB-12V

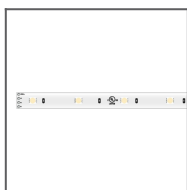

LED pásek K-1215-RGB-24V 7.2W/m  
Ref: K-1215-RGB-24V

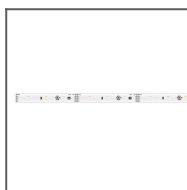

LED pásek K-1225-RGB-12V 11.5W/m  
Ref: K-1225-RGB-12V

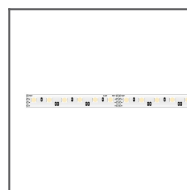

LED pásek K-1225-RGB-24V 11.5W/m  
Ref: K-1225-RGB-24V

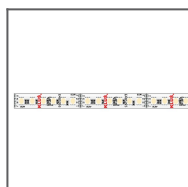

LED pásek K-1920-120-RGB-24V 19.2W/m  
Ref: K-1920-120-RGB-24V

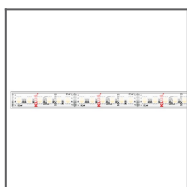

LED pásek WP-K-1920-120-RGB-24V  
Ref: WP-K-1920-120-RGB-24V

#### NASTAVENÍ TEPLoty BARVY / TEPLÉ BARVY

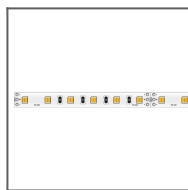

LED pásek K-27/65-1920-24V 19.2W/m  
Ref: K-27/65-1920-24V

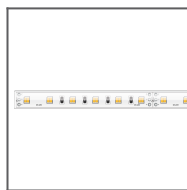

LED pásek WP-K-27/65-1920-24V  
Ref: WP-K-27/65-1920-24V

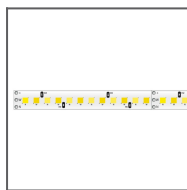

LED pásek K-22/50-1728-24V 17.28W/m  
Ref: K-22/50-1728-24V

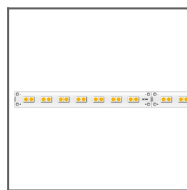

LED pásek K-30/18-1770-24V 11.5W/m  
Ref: K-30/18-1770-24V

#### MARKETINGOVÉ MATERIÁLY



Panel P230-90074M  
Ref: 90074M



Prezentační box 5  
Ref: 90124