

## POPIS PRODUKTU

- Navrženo pro dosažení krytí IP67
- Malý rozměr (16 mm x 16mm)
- Profil směřuje světlo pod úhlem 45°

### ÚPRAVA :

Stříbrně anodizovaný

\*Vlastní barvy jsou k dispozici na vyžádání

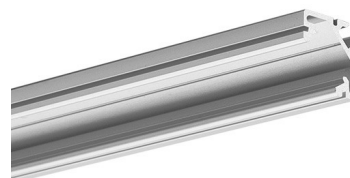

Vyplňte prázdná pole

Číslo produktu

Typ  
příslušenství

Firma

Projekt

Datum

## TECHNICKÁ SPECIFIKACE

### Účel produktu

- pro montáž na rovné plochy a do vnitřních 90° rohů
- pro vytváření směrových svítidel

### Instalace

- k přisazení na povrch za použití úchytek PDS-STN, REG-PD, PL-PDM
- k přisazení na povrch za použití profesionálních oboustranných lepicích pásek a montážních lepidel

### Další informace

- možnost výroby liniového svítidla s krytím IP67 - tedy prachotěsné a vodotěsné svítidlo
- nízká hmotnost
- možnost nepřímého svícení
- prostor pro LED pásek: 11.2 mm

## DOSTUPNÉ DÉLKY

Ref.	povrchová úprava	dostupné délky
B8504ANODA_1	Stříbrně anodizovaný	1000 mm
B8504ANODA_2	Stříbrně anodizovaný	2000 mm
B8504ANODA_3	Stříbrně anodizovaný	3000 mm

TECHNICKÝ VÝKRES

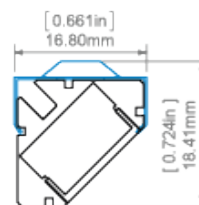
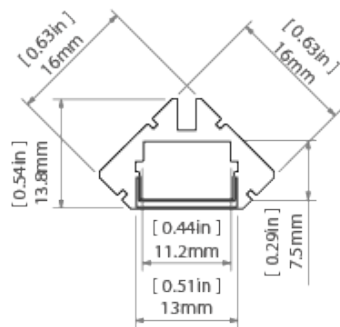

45-16 profile and PDS-STN mounting bracket  
profil 45-16 z mocovníkem PDS-STN

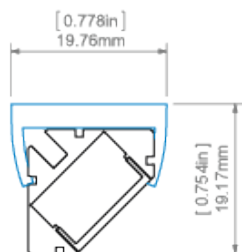

45-16 profile and PL-PDM mounting bracket  
profil 45-16 z mocovníkem PL-PDM

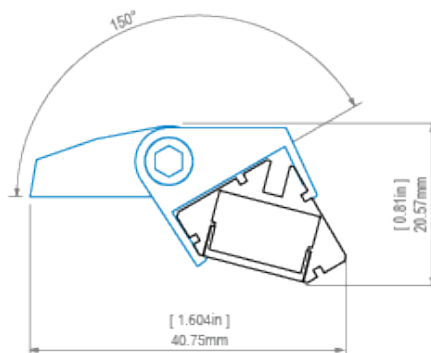

45-16 profile and REG-PD-UV mounting bracket  
profil 45-16 z mocovníkem REG-PD-UV

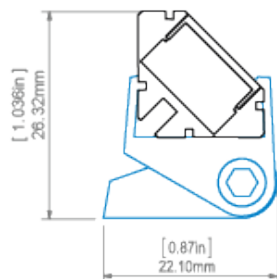

45-16 profile and REG-PD-UV mounting bracket  
profil 45-16 z mocovníkem REG-PD-UV

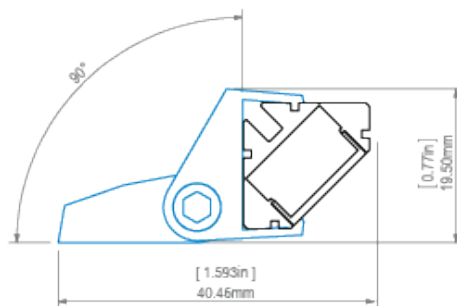

45-16 profile and REG-PD-UV mounting bracket  
profil 45-16 z mocovníkem REG-PD-UV

## SOUVISEJÍCÍ PRODUKTY

### DIFUZORY

#### ČERNÉ DIFUZORY

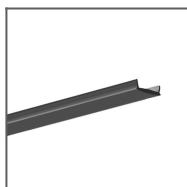

Difuzor LIGER  
černý  
Ref: 17040

#### ČIRÉ DIFUZORY

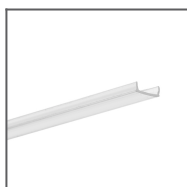

Difuzor KA čirý  
Ref: 17036

70°

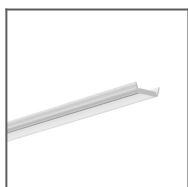

Difuzor HS čirý  
Ref: 1370

60°

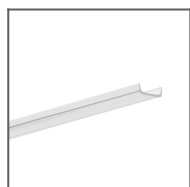

Difuzor KA-COM čirý  
Ref: 17122

100°

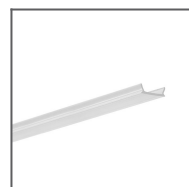

Difuzor KA-PRO čirý  
Ref: 17065

70°



#### MLÉČNÉ DIFUZORY

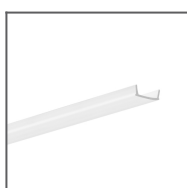

Difuzor KA mléčný  
Ref: 17035

100°

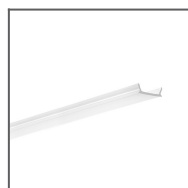

Difuzor KA-PRO  
mléčný  
Ref: 17064

100°

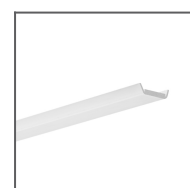
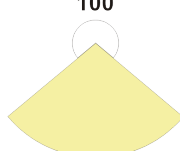

Difuzor HS mléčný  
Ref: 1369

100°

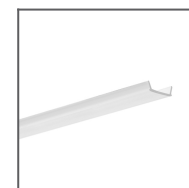

Difuzor KA-COM  
mléčný  
Ref: 17121

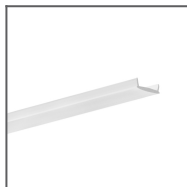

Difuzor LIGER mléčný  
Ref: 17037

110°



## ZÁSLEPKY

## ZÁKLADNÍ

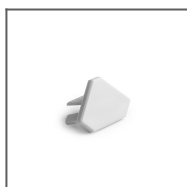

Záslepka 45-16  
šedá  
Ref: 24206

## PŘÍSLUŠENSTVÍ

### ZÁVĚSNÉ PRVKY

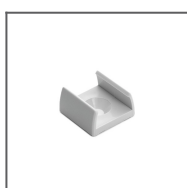

Úchytka PL-PDM  
Ref: 24041

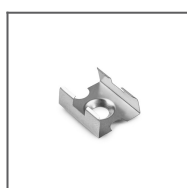

Úchytka PDS-STN  
Ref: 24190



Úchytka REG-PD-UV  
Ref: 24270

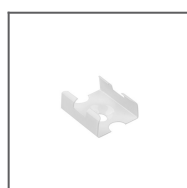

Úchytka PDS  
Ref: 24223

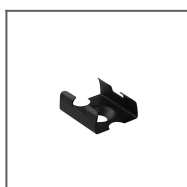

Úchytka PDS  
černá  
Ref: 24189



Hlavice ST  
Ref: 42216



Hlavice ZO  
Ref: 42217



Hlavice ZZ  
Ref: 42218



Závěska FI-8-LIN-MR stříbrná  
Ref: 42287

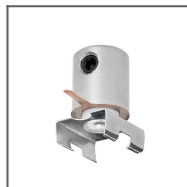

Závěska DP-MOC-ZZ  
Ref: 00647



Závěska DP-MOC  
Ref: 00645



Závěska DP-MOC-ZO  
Ref: 00646

## SPOJOVACÍ PRVKY PROFILŮ

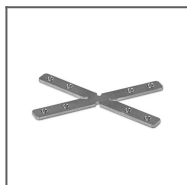

Úhlová spojka  
ZM-X60-G  
Ref: 42332

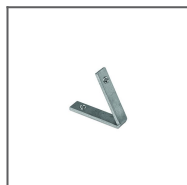

Úhlová spojka  
ZM-NA-PION-60  
Ref: 42317

## SESTAVY PRO UCHYCENÍ



Sestava uchycení  
M3  
Ref: 42303



Sestava uchycení  
M4  
Ref: 42301



Sestava uchycení  
M5  
Ref: 42302



Sestava uchycení  
W9  
Ref: 42607



Sestava uchycení  
W10  
Ref: 42608

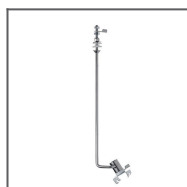

Sestava uchycení  
M14  
Ref: 42612



Sestava uchycení  
RG-1 černá  
Ref: 42647L9005



Sestava uchycení  
RG-1 stříbrná  
Ref: 42647NI

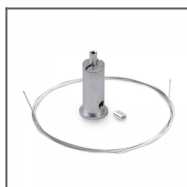

Sestava uchycení  
RG-1 stříbrný  
satén  
Ref: 42647GSS

## TĚSNÍCÍ PRVKY



Gumová  
průchodka 6x1,2  
Ref: 00802

## MARKETINGOVÉ MATERIÁLY



Panel  
P230-90106M  
Ref: 90106M



Prezentační box 6  
Ref: 90125

## LED PÁSKY

### BÍLÁ

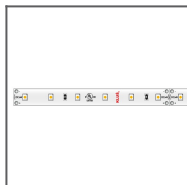

LED pásek  
K-1210-24V  
4.8W/m  
Ref: K-1210-24V